

## Tech Bulletin 2011-001

### IPitomy RAID

#### Description

IPitomy now delivers RAID-1 on all platforms of the IPitomy IP PBX. RAID is "Redundant Array of Independent Disks". RAID-1 is the mirroring of data onto two or more independent Hard Disk Drives. (HDD-Array) (Two HDD's maximum in IP1100 and IP1200.)

Hospitals, Call Support Centers and any organization that strives to provide the highest level of customer service and shave-off possible down-time will find RAID indispensable.

IPitomy RAID comes in two configurations:

- **Software RAID** (new for all platforms)
- **Hardware RAID** (new Hot Swap capability)

IPitomy RAID is available in software and hardware variations to allow its deployment onto the smallest system configuration.

Software RAID can be implemented on any platform and delivers the basis of RAID security. RAID status is presented to the user/dealer via the Standard IPi-tomy software interface.

Hardware RAID can be implemented only on the IP2000 and above since it includes a Hard Disk Drive Array controller board. Hardware RAID now includes **Hot Swap** operation. Swapping-out the defective drive is possible during run-time with the Front Panel access without opening the chassis! The utility SW resides on the PBX in the software level between the hardware interface BIOS and application layers. HW RAID is recommended for all larger system applications.

RAID is configured at IPitomy and shipped as a complete product solution. It is not available as a field upgrade.

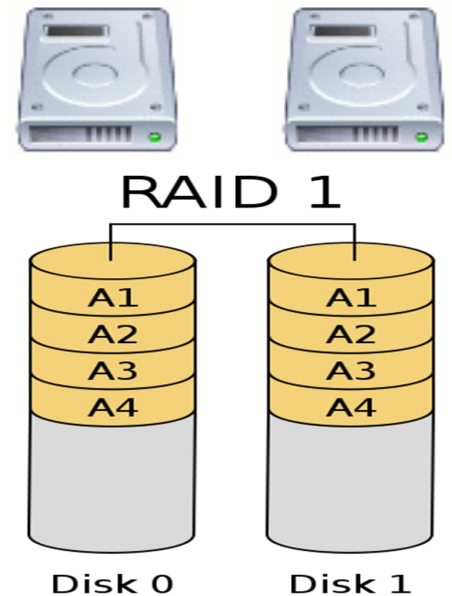

**Caution: These RAID HDD replacement procedures assume a confident awareness of the interior of PC-Based PBX's and servers!**

RAID related features	IP1100	IP1200	IP2000	IP5000
<b>Mirroring Hard Disks (2x)</b>	SW RAID	SW RAID	SW RAID HW RAID	SW RAID HW RAID
<b>Automatic Redundancy</b>	SW RAID	SW RAID	SW RAID HW RAID	SW RAID HW RAID
<b>Hot Swappable Hard Drive</b>	NA	NA	HW RAID	HW RAID
<b>Front Panel Hard Drive Access</b>	NA	NA	SW RAID HW RAID ("e" series)	SW RAID HW RAID
<b>Dual Supply Power</b>	NA	NA	Yes	Yes

Tech Bulletin 2011-001

IPitomy RAID

**RAID Configurations / Redundancy Options**

<u>Product</u>	<u>Description</u>	<u>Part Number</u>
Software RAID	Add software RAID for Redundant Hard Drive mirroring. If one drive fails, the other takes over automatically reducing downtime due to drive failure and ensuring a more reliable performance.	SW-RAID
Hardware RAID	Hardware RAID and One SATA Drive for a total of 2 SATA drives. This is only an option on the IP2000 chassis. Hardware RAID and two drives are included on the IP5000 and IP2000-E Chassis.	IPRAID
Redundant Power Supply	4U power supply for IP2000/5000 with two independent replaceable hot swappable power supplies contained in one unit. <b>PRODUCT TECHNICAL SPECIFICATIONS:</b> <ul style="list-style-type: none"> <li>• <b>Hot-Swap:</b> This means when either one of the redundant power supply fails or breaks down, you can easily replace failed unit without any interference to the system.</li> <li>• <b>Buzzer:</b> A warning buzzer sounds when any one of the power supplies fails.</li> <li>• <b>LED's:</b> Tells if one of the two power supplies has failed by LED blink</li> </ul>	REDPS
SATA Front Loading Rack	Front Cabinet Accessible Mobile Rack for SATA Drives - Add to IP2000 Chassis as an Option. Should order 2 units for both mirrored SATA drives so both drives will be accessible. This is only an option on the IP2000 chassis. This unit is included in the IP5000 and IP2000-E Chassis	KF-91

**RAID**

**Procedure**

Since the RAID options are installed at IPitomy no user servicing is required to install RAID.

This procedure guides the service technician through restoring a system to RAID protected status when a Degraded Array (failure) has occurred.

(In RAID-1 data is stored on multiple drives (an Array) as a single drive.)

In the screen shot at the right the PBX is reporting:

"RAID Status: OK".

This screen capture is from:

**PBX Setup/Services/**

**System Information**

System Software Version: 3.4.2 (3147c4111a6ec8e5ca24339e74d185cbe753a17d)

RAID Status: OK



OK



OK



**Note: RAID HDD replacement assumes a confident awareness of the interior of PC-Based PBX's and servers!**

## Tech Bulletin 2011-001

### IPitomy RAID

#### Procedure - Hardware RAID—Drive Removal—Hot Swap

1. When a failure occurs the displayed information will show which drive has failed.
2. If your PBX is equipped with HOT Swap (SATA Front-Loading HD access)... it will be very easy to replace the bad drive.

System Information	Drive 0   Drive 1   Drive 2
System Software Version: 3.4.2 (3147c4111a6ec8e5ca24339e740165c0e753a170)	
RAID Status: <b>0% REBUILDING</b>	 <b>DEGRADED</b>  <b>OK</b>

3. In the screen example (from **PBX Setup/Services/**) the failed Array drive is indicated. In this case it is Drive 0.

 **Note: Be sure to pull the correct (failed) drive as pulling the good drive will interrupt service!**

4. Locate the defective drive in the PBX.
5. **TAKE Care to remove the correct drive!** Using the System Information screen (**PBX Setup/Services/**)... IDENTIFY the failed drive. In the display the left-most drive is Drive 0, the Center or Right displayed drive is Drive 1. If there are three drives, the right-most drive is Drive 2.
6. With HOT SWAP just find the key for the Front Panel door. Behind it are two or three HDD's.



7. Open the Front Panel door . The top-most drive is Drive 0. The Center or bottom drive is Drive 1 and if there are three HDD's the bottom-most drive is Drive 2.
8. Based on the failed drive information turn the key-release of that drive and lift the securing handle. This will gently and safely disengage the drive from the connector buss.
9. Once removed you'll find that the Front Loader is a carrier assembly and the actual HDD is mounted inside of that carrier. Remove the original—defective HDD.



**Drive 0**  
**Drive 1**  
**Drive 2**

10. Replace the HDD.

## Tech Bulletin 2011-001

### IPitomy RAID

11. It is best to match the HDD that is being replaced. If this is not possible, get a replacement HDD with similar specifications and storage capacity. You must match or exceed the storage capacity to assure capacity is available for RAID storage. RAID will configure the media installed to the extent of the smallest capacity HDD. **Use a new drive.** A drive from another source—particularly another RAID-enabled system may be recognized as the data SOURCE! You could lose all existing data!

12. Continue to: Hardware RAID Restore Procedure.

**USE A NEW DRIVE as REPLACEMENT!**



### Procedure - Hardware RAID—Drive Removal —Without Hot Swap

1. When a failure occurs the displayed information will show which drive has failed. In this case the failed Array drive is Drive 0.

System Information		Drive 0   Drive 1   Drive 2	
System Software Version: 3.4.2 (3147c4111a6ec8e5ca24359e74d105c0e753a17d)			
RAID Status: <b>0% REBUILDING</b>			
			
		<b>DEGRADED</b>	OK

2. If your PBX is NOT equipped with HOT Swap you must open the PBX and replace the HDD. Be sure to allocate enough time to perform this task since the PBX will be off-line and powered-down for the procedure.
3. POWER OFF the PBX; this is most efficiently accomplished using the momentary switch on the front panel. Open the key panel door and locate the rocker switch. It's a momentary switch and will return to its idle position.
4. Press this button on the raised side—it may also be printed with a dot or large "I".
5. Once pressed the PBX will begin it's power-down sequence. When this is complete the system running LED will be OFF.
6. At this time you should be wearing a grounded wrist-strap to prevent ESD damage to components inside the PBX.



**Note: If your system power supply has a On/Off switch, put it in the OFF position.**

7. Not all power supplies are the same. If your power supply has an ON/OFF switch, move it to the OFF position. Go to step 8.

8. Disconnect the power cord at the back of the PBX cabinet where it enters.
9. Remove the housing cover screws—depending upon the genre of case these vary in location. Usually the case screws are at the sides of the case lid.
10. The case lid must be pushed backward to free it from the front panel mated-lip. Do so and lift the case lid up and off of the housing.
11. Inside the PBX, locate the HDD that will be replaced using the next few steps to identify the drive.

## Tech Bulletin 2011-001

### IPitomy RAID

12. Hardware RAID includes a controller board to which the HDD's are connected. Locate this board, it's the one with the SATA wires connected from the HDD's.
13. Matching the actual HDD to that in the **PBX Setup/Services** displayed is done by tracing the wire from the corresponding port to the HDD. Some versions of PBX software will also indicate the HDD serial number.
14. In the photo below, the HDD connectors on the RAID board are labeled to assist in this identification.
15. The SATA connector closest to the RAID board is SATA 1 and the connector furthest from the board is SATA 0 (notice the labels applied to the photo.)

16. Using the wire connected to the SATA port associated to the defective HDD, locate the drive that is to be removed.

17. Disconnect the SATA cable and power cable from the HDD.

18. Use standard PC hardware tools to remove the HDD from the chassis.

19. Replace the HDD. It is best to match the HDD that is being replaced. If this is not possible, get a replacement HDD with similar specifications and storage capacity. You must match or exceed the storage capacity to assure capacity is available for RAID storage. RAID will configure the media installed to the extent of the smallest capacity HDD. **Use a new drive.** A drive from another source—particularly another RAID-enabled system may be recognized as the data SOURCE! This can result in complete loss of existing data!

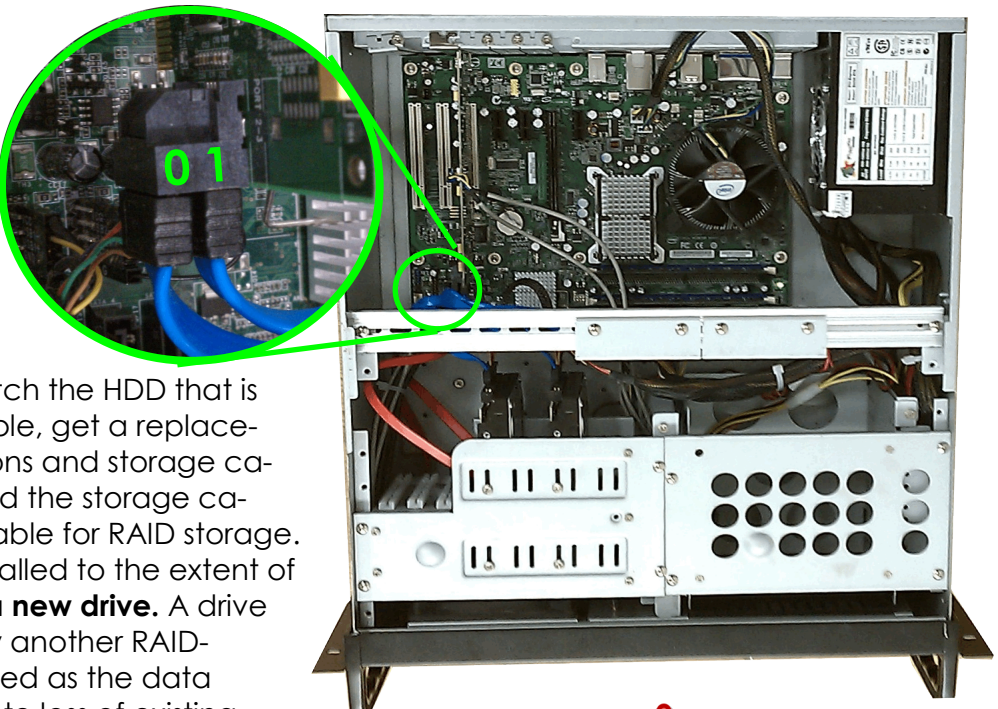

**USE A NEW DRIVE as REPLACEMENT!**



20. Install the new HDD using the hardware supplied with the drive.
21. Connect the SATA cable and power cable to the drive.
22. Use cable ties and secure the wiring so that it cannot become pinched when the chassis cover is replaced. Also assure that wiring does not obstruct fan blades.
23. Replace the chassis lid making sure to position the front edge under the housing front mated lip and secure with the screws previously removed.
24. Continue to: Hardware RAID Restore Procedure.



**Note: Be sure to find the correct (failed) drive!**

## Tech Bulletin 2011-001

### IPitomy RAID

#### Procedure - Hardware RAID—Restore

When the HDD has been replaced the RAID Array must be rebuilt so that RAID redundancy is restored. The steps here assume that the HDD has been replaced. If not, return to the previous Procedures to replace the defective drive, then return here to restore RAID functionality. This procedure requires the use of an ancillary (spare) Keyboard and monitor.

1. With the new HDD installed and the chassis case closed, restore power to the PBX.
2. Reconnect the power cable to the PBX Chassis power supply.
3. Not all power supplies are the same. If your PBX PS has an On/Off switch, move it to the ON position.
4. An ancillary (spare) keyboard and monitor must be connected to the PBX.
5. Locate the Keyboard and monitor connectors on the PBX chassis.



**Note: If your system power supply has a On/Off switch, move it to the ON position.**



**Note: An ancillary (spare) keyboard and monitor are required for this procedure.**

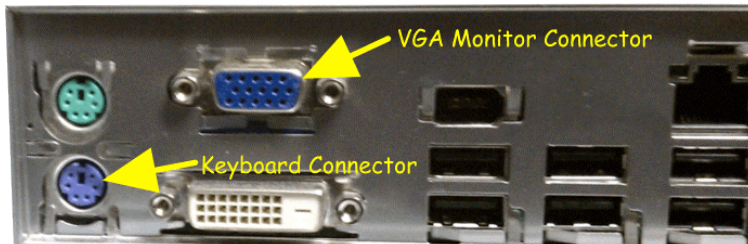

6. Connect a PS-2-type keyboard and VGA monitor to the corresponding connectors on the PBX.
7. Now the PBX can be booted.
8. Use the Boot-Up/Power-Down button on the front panel to start the boot-up.
9. Press this button on the raised side, it may also be printed with a dot or large "I".
10. Watch the monitor closely during the boot-up sequence. There is only about a three-second window wherein Alt-3 MUST be pressed to start the RAID—layer software.



**Note!!! You have about 3-seconds to start the RAID-layer software... Press Alt-3**

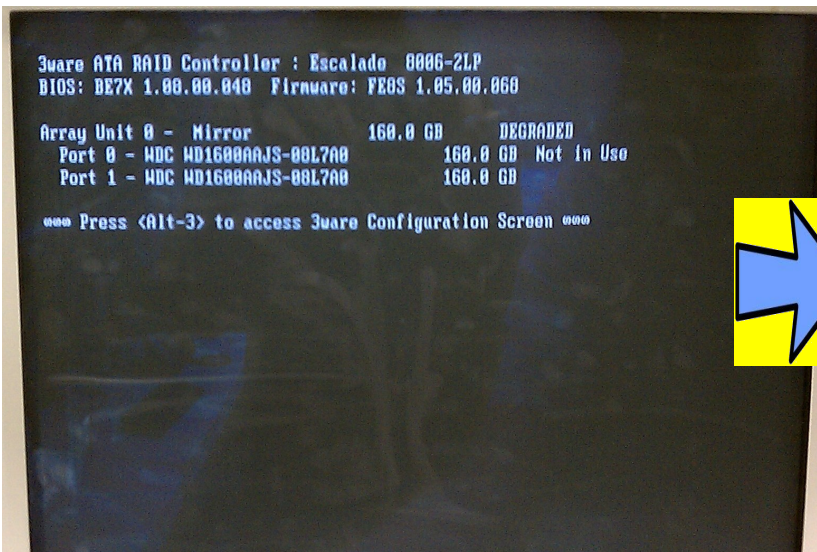

11. If you miss this screen allow the PBX to fully boot-up and then use the same Boot-Up/Power-Down switch to Power Down the PBX and then repeat steps from Step 8.
12. The RAID-layer software utility will start and

## Tech Bulletin 2011-001

### IPitomy RAID

you should see a screen similar to the one at the right.

13. Press Any Key to Continue.
14. The next screen will indicate the Degraded drive in the Array. There will only ever be one Array in the IPitomy PBX... it is labeled "Array Unit 0".
15. Notice that there are two HDD's listed in this Array. The HDD identifications are listed below the Array header. Notice "Port 0" and "Port 1" are listed for Array Unit 0. These numbers correspond to the displayed HDD's in the PBX interface software (**PBX Setup/Services/**).
16. In this example, HDD "0" was the failed drive. Since it has been replaced the new HDD is listed here as "Not in Use".
17. Use the arrow buttons on the keyboard to move to and select the Array. (There is only one.)
18. Press Space bar to select this Array. (An asterisk will appear adjacent to the array title.)
19. Now use the Tab button to select "Rebuild Array".

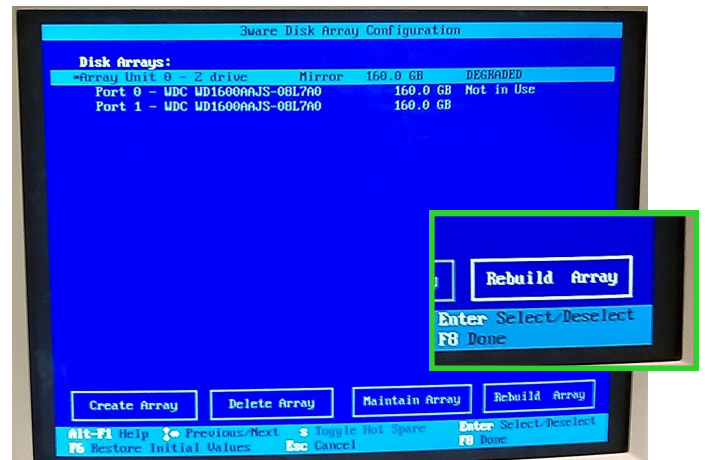
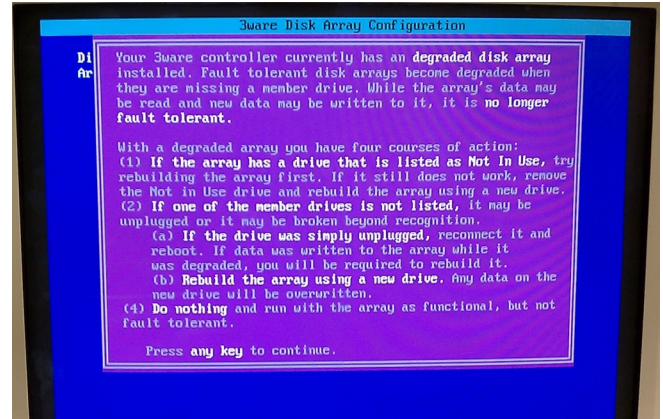

 **Note: Select the Array and then select Rebuild Array.**

20. Press Enter.
21. The option; "Continue on source error:" appears. We suggest you leave this as "disable".

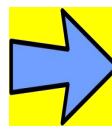
 **Note: "Continue on source error:" should be "disable".**

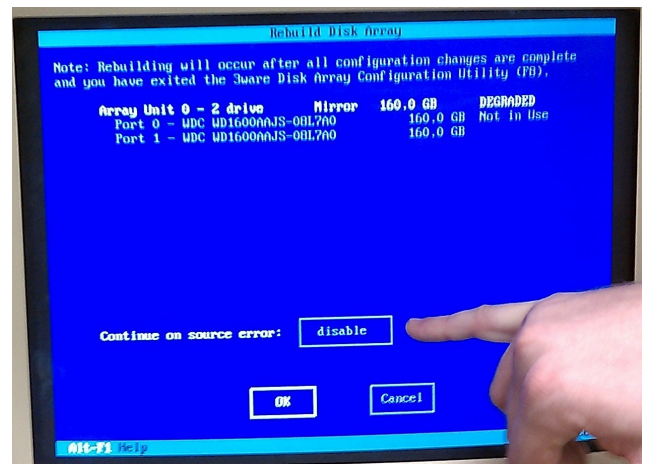

22. Position the cursor on "OK" and press Enter.
23. The last confirmation window appears. Press "Y" (yes) to confirm that the array is to be rebuilt.
24. Press "F8" to start the process.
25. Following this the PBX will reboot. Depending on PBX activity and HDD size and source content the time required to rebuild the Array will vary. Fortunately you don't have to wait... this process will continue in the background while the PBX is running.
26. Go to **PBX Setup/Services/** to view the progress of the rebuild.  
(Be patient the process can take 2 hours.)

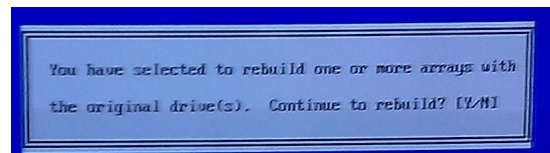

 **Note: Do not interrupt power while rebuilding the Array.**

## Tech Bulletin 2011-001

### IPitomy RAID

#### Procedure - Software RAID Drive Removal

1. When a failure occurs the displayed information will show which drive has failed.
2. This screen (from **PBX Setup/Services/**) shows that Drive 1 has failed. A failure is denoted by the word "degraded" in the RAID Status display.
3. Locate the defective drive in the PBX.

4. **TAKE Care to remove the correct drive!** Using the System Information screen (**PBX Setup/Services/**)... IDENTIFY the failed drive. In the display the left-most drive is Drive 0, the Center or Right displayed drive is Drive 1. If there are three drives, the right-most drive is Drive 2.

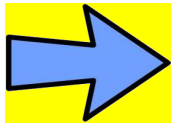

**Note: Be sure to find the correct (failed) drive! Write down the failed drive ID (0 or 1 or 2)**

5. POWER OFF the PBX; this is most efficiently accomplished using the Boot/Power-Down switch on the front panel. It's a momentary switch and will return to its idle position.
6. Press this button on the raised side—it may also be printed with a dot or large "I".
7. Once pressed the PBX will begin it's power-down sequence. When complete the PBX LED will be OFF.
8. At this time you should be wearing a grounded wrist-strap to prevent ESD damage to components inside the PBX.

Boot/Power-Down SW  
IP1100 IP1200

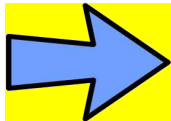
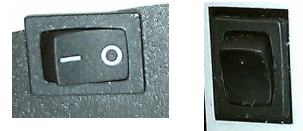

**Note: Software RAID is typically installed in the IP1100 or IP1200 and there is no switch on the power supply.**

9. If working on IP2000 or greater: Not all power supplies are the same. If your power supply has an ON/OFF switch, move it to the OFF position. Otherwise skip this step.
10. Disconnect the power cord at the back of the PBX cabinet.
11. Remove the housing cover screws—depending upon the genre of case these vary in location. Usually the case screws are at the sides of the case lid. In some cases there will be a screw at the back as well.
12. The case lid must be pushed backward to free it from the front panel mated-lip. Do so and lift the case lid up and off of the housing.
13. Inside the PBX, locate the HDD that will be replaced using the next few steps to identify the drive.
14. Matching the actual HDD to that in the **PBX Setup/Services** displayed is done by tracing the wire from the corresponding port to the HDD.



## Tech Bulletin 2011-001

### IPitomy RAID

15. In the photos, the HDD connectors on the PBX Motherboard are labeled "SATA 0" and "SATA 1" to assist in this identification.
16. If your version of PBX SW supports serial number identification—use that number to ID the HDD and skip to Step 18. Otherwise continue to ID the defective HDD with Step 17.
17. Using the wire connected to the SATA port associated to the defective HDD, locate the drive that is to be removed.
18. Disconnect the SATA cable and power cable from the HDD.
19. Use standard PC hardware tools to remove the HDD from the chassis.
20. Replace the HDD. It is best to match the HDD that is being replaced. If this is not possible, get a replacement HDD with similar specifications and storage capacity. You must match or exceed the storage capacity to assure capacity is available for RAID storage. RAID will configure the media installed to the extent of the smallest capacity HDD. **Use a new drive.** A drive from another source—particularly another RAID-enabled system may be recognized as the data SOURCE! This can result in complete loss of existing data!
21. Install the new HDD using the hardware supplied with the drive.
22. Connect the SATA cable and power cable to the drive.
23. Use cable ties and secure the wiring so that it cannot become pinched when the chassis cover is replaced. Also assure that wiring does not obstruct fan blades.
24. Replace the chassis lid making sure to position the front edge under the housing front mated lip and secure with the screws previously removed.
25. Continue to Software RAID Restore Procedure.



**USE A NEW DRIVE as REPLACEMENT!**

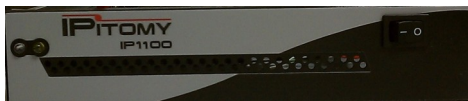

IP1100

IP1200

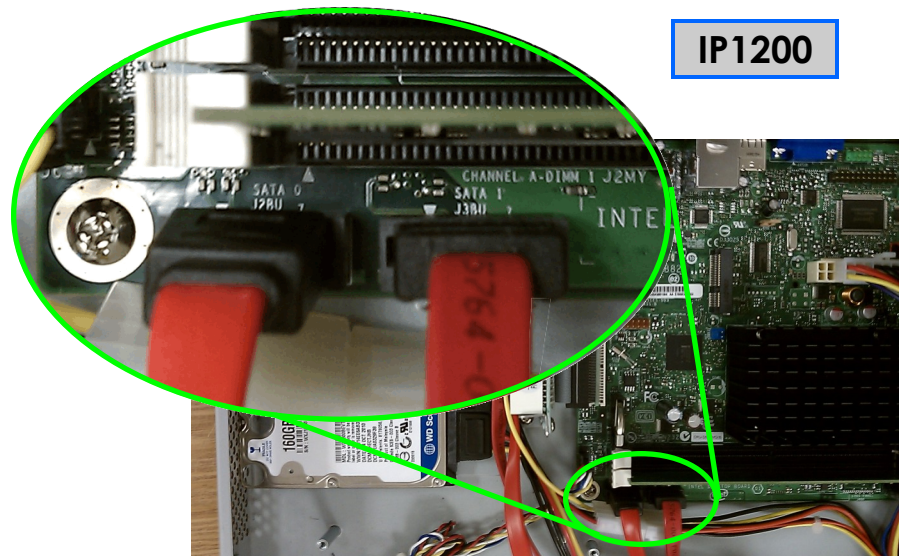
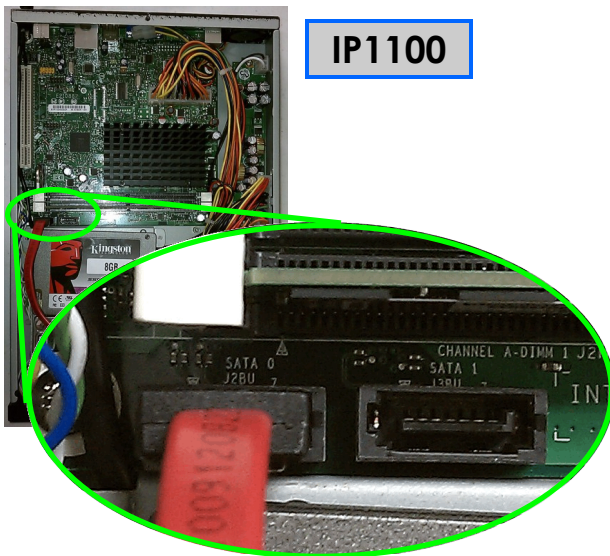

## Tech Bulletin 2011-001

### IPitomy RAID

#### Procedure - Software RAID—Restore

When the HDD has been replaced the RAID Array must be rebuilt so that RAID redundancy is restored. The steps here assume that the HDD has been replaced. If not, return to the previous Procedures to replace the defective drive, then return here to restore RAID functionality. This procedure requires the use of an ancillary (spare) Keyboard and monitor.

1. With the new HDD installed and the chassis case closed, restore power to the PBX.
2. Reconnect the power cable to the PBX.
3. Not all power supplies are the same. If your PBX PS has an On/Off switch, move it to the ON position.
4. Use the Boot-Up/Power-Down button on the front panel to start the PBX.
5. Press this button on the raised side, it may also be printed with a dot or large "I". It is a momentary switch and will return to its idle position.
6. When the PBX has booted, log into the PBX Administration GUI (web page).
7. Navigate to the **PBX Setup/Services/** page.  
You should see a screen similar to this:

Boot/Power-Down SW  
IP1100      IP1200

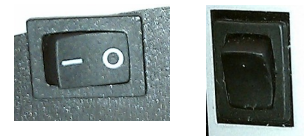

8. Click on the "Rebuild Array" button to start the Array rebuilding process. Note: this process will continue in the background while the PBX is operation. Depending on PBX activity and HDD size and source content the time required to rebuild the Array will vary. Fortunately you don't have to wait... this process will continue in the background while the PBX is running. Progress can be reviewed at this same page (via percent complete notation):



**Note: Do not interrupt power while rebuilding the Array.**  
The process can take 2 hours